

HIT-W183

Innovative 18.5" Healthcare/Hospitality Information Terminal



Features

- Innovative and ultra-slim design for healthcare and hospitality applications
- All-in-one computer with Intel® Apollo Lake N4200 CPU
- True-flat touch screen for easy cleaning
- Win 10 IoT LTSC 2019, Android 10/12
- Supports M.2 2230 WiFi / BT modules and M.2 2242 SSDs
- Supports RFID/NFC/Web Camera/Smart Card Reader
- Dual isolated Ethernet – Internet (for patients) and intranet (for hospitals) network traffic management and data security
- Supports nurse call button & LED indicator
- Rich optional peripherals – Handset / HDMI In/2nd Smart Card Reader, Barcode Scanner, RFID+HID
- Medical and ITE dual certification (EN 60601-1 & IEC 62368) to provide complete application coverage
- Equipped with DeviceOn/iService software for remote device management



Introduction

HIT-W183 is an innovative product in the HIT-series, featuring a 43mm thin body enclosure, USB 3.0, 5 megapixel camera, and dual isolated Ethernet, which lets hospitals separate and manage internal and external network traffic. The HIT-W183 also features a dedicated audio codec for our background noise-canceling handset to guarantee the best audio quality for calls to nurse stations. The available nurse call button and the LED indicator can be easily linked to existing nurse call systems in hospitals, and can be operated independently, even when the system is off. HIT-W183 is ideal for applications in hospitals, such as bedside information terminals, IP nurse call stations, and treatment centers. It can also be used as an HMI interface for medical equipment.

Moreover, HIT-W183 is equipped with Advantech's DeviceOn/iService software, which is a next-generation unified device management solution based on the WISE-DeviceOn platform. With support for batch operations and multi-device control, DeviceOn/iService enables easy device configuration and deployment for convenient remote device management.

Specifications

Hardware	CPU	Intel® Apollo Lake N4200 (2M Cache, up to 2.5 GHz)
	Memory	DDR3L x 1, up to 8GB (Default 4GB)
	Primary Storage	M.2 2242 SSD (Default 64GB)
	Camera	5MP CMOS
	Bus Expansion	Mini-PCIe x 1
Display	Size	18.5" W TFT LED
	Max Resolution	1920 x 1080 FHD
	Luminance	350 cd/m ²
	Contrast Ratio	1000:1
Touchscreen	Type	Projected Capacitive
Front Button	Hotkey	Screen on/off
		Volume up
		Volume down
		Brightness up
		Brightness down
I/O Ports	USB 3.0	1 (Rear)
	USB 2.0	2
	Smart Card Reader	1 (Default), Optional 2nd reader
	RFID/NFC	1 (optional RFID+HID)
	Audio Jack (TRRS)	1
	Handset Out(RJ12)-Hide in the left side	1
	Nurse Call Phoenix Port (4-pin)	1
	DC-in	1
Audio	Speaker	3 Watt x 2
	Internal Microphone	1
Network	LAN (Isolated)	Isolated RJ45 (10/100/1000 Mbit) x 2
	Bluetooth	BT 4.1 (Default Module)
	WLAN	802.11 a/b/g/n/ac (Default Module)
Software	OS	Win 10 IoT LTSC 2019, Android 10/12

Specifications (Cont.)

Mechanical	Mounting	VESA 75 x 75 mm & 100 x 100 mm
	Dimensions (W x H x D)	466.4 x 311.5 x 43 mm (18.4" x 12.3" x 1.7")
	Weight	Net Weight (w/o adapter): 8.58lb, 3.89kgs Gross Weight: 13.1 lb, 5.94 kgs
Option	HDMI In	Optional (Built-in Module)
	2nd Smart Card Reader	Optional (Built-in Module)
	Handset	Optional (Add-on Module)
	Barcode Scanner	Optional (Bottom)
Power Supply	AC/DC Adapter	
	Input Voltage	100 – 240V _{AC} , 1.1 – 0.45A @ 47 – 63Hz
	Output Voltage	ITE or Medical 18-19 V _{DC} , 3.42A
Environment	Operating Temperature	0 – 40°C
	Vibration	1G
	Shock	10G Peak Acceleration (11ms duration)
	EMC & Safety Cert.	CE, FCC, CCC, CB, UL ITE & Medical, EN 60601-1& IEC 62368, BSMI

DeviceOn/iService Specifications

DeviceOn/iService Remote Device Management	Operating System	Windows 10	Android 8
	Common Controls (Reboot, Shutdown)	✓	✓
	Remote desktop	✓(VNC)	✓(VNC)
	Device-Specific Controls (Audio, Backlight)	✓*	✓*
	Connection Status	✓	✓
	Hardware Status	✓*	✓*
	Hard Disk Status	✓*	
	Batch Operation Support	✓	✓
	OTA Storage Management	FTP	Local blob
	OTA Software Updates	✓	✓
	Software Watchlist	✓	✓
	Software Start/Stop	✓*	✓
	Kiosk Mode		✓
	Dependant on device model	Peripherals Watchlist	✓

Note: DeviceOn/iService software must be downloaded from the Advantech website at <https://www.advantech.com/search/?q=DeviceOn%2FiService&st=support&sst=Utility>

Dimensions

Unit: mm

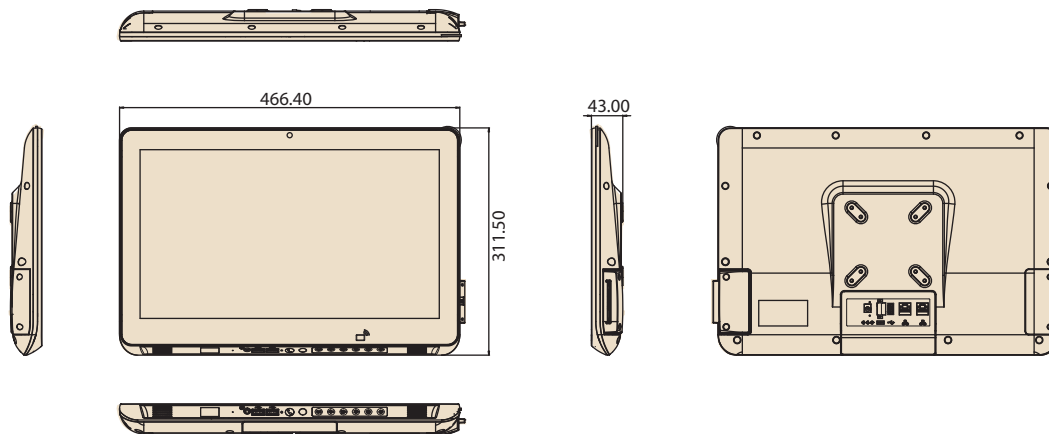

Ordering Information

Part Number	Description
HIT-W183AP-AMW1E	18.5" Wide Screen, Intel Celeron N4200, PCAP Touch, 4G RAM, 64G SSD, Web Camera, Smart Card Reader, WiFi/BT, RFID, Medical Adapter, Win10 IoT Embedded
HIT-W183AP-ATW1E	18.5" Wide Screen, Intel Celeron N4200, PCAP Touch, 4G RAM, 64G SSD, Web Camera, Smart Card Reader, WiFi/BT, RFID, ITE Adapter, Win10 IoT Embedded

Accessories

Part Number	Description
HIT-W183-HSK0E	HIT-W183 & HIT-W153 Handset Kit
1700001524	Power cord USA 1.83M (for ITE)
170203180A	Power cord UK 1.83M (for ITE)
170203183C	Power cord EU 1.83M (forITE)
1702002600	Power Cable USA 1.8 M (for Medical)
1702002605	Power Cable EU 1.8 M (for Medical)
1700018704	Power Cord UK 1.8 M (for Medical)
HIT-STD-W001-C	HIT Stand for 11.6, 15.6, 18.5
PDC-W215-STAND-H3E	PDC-W215 STAND_H3-741L type_6-12kg BLACK

Peripherals for HIT-W183 Series

Part Number	Description
TBSD-WS1502	Table Stands
TBSD-WS1510	
TBSD-WS1702	
TBSD-WS2710	
MNT-MMWB8615	ARMs & Mounting
MNT-MTWHM03	
ARM-MBWHA306	
ARM-MBWHA506	
ARM-MBWHA621	Keyboards/Mouses/Scanners
KBD-MCWU1020	
KBD-MCWU1010	
MOU-MCWU1001	
SCN-MCWIG829	

Fully- Integrated I/O

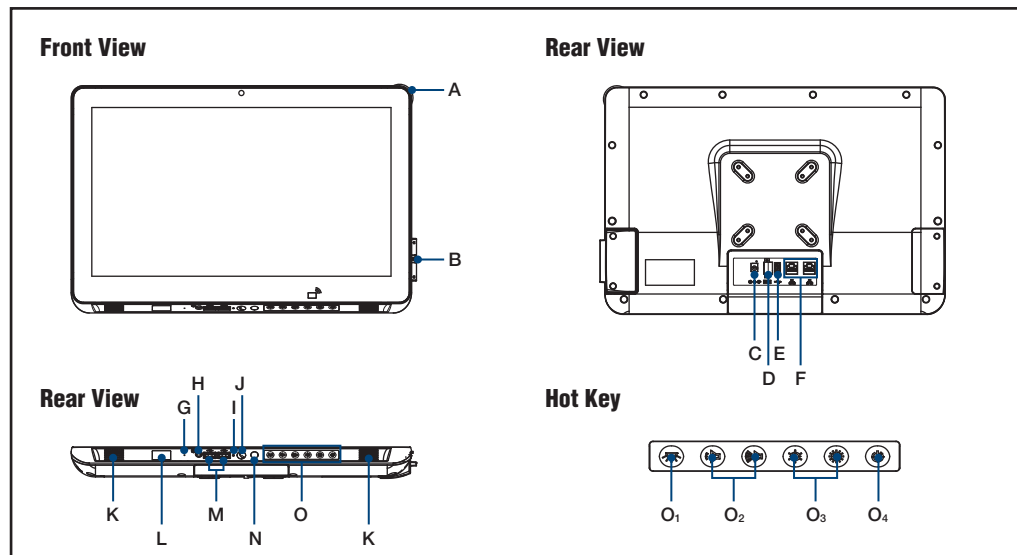

- A. Alarm lens
- B. Smart card reader
- C. DC jack
- D. Digital I/O Phoenix port (4 pin)
- E. USB 3.0
- F. Isolated RJ-45 LAN
- G. Mic
- H. Audio jack (TRRS)
- I. Reset button
- J. Nurse call button
- K. Speaker
- L. Barcode scanner (optional)
- M. USB 2.0
- N. Reading Light
- O. Hot key
 - O₁. Reading light on/off
 - O₂. Volume up/down
 - O₃. Brightness up/down
 - O₄. Screen on/off

DeviceOn/iService

Unified Remote Device Management Software





Features

- Supports Advantech devices equipped with Windows, Android, and Linux OS
- Flexible device, location, user, and permissions management
- Enables remote monitoring and control of hardware, software, and peripherals
- Supports over-the-air (OTA) firmware and software updates
- Ensures quick, easy, and secure device onboarding
- RESTful APIs for third-party system integration



Introduction

Advantech's DeviceOn/iService is a next-generation unified device management solution based on the WISE-DeviceOn platform. Designed to enable centralized monitoring and remote management, DeviceOn/iService supports Advantech devices equipped with Windows, Linux, or Android operating systems. The software also supports the management of applications and integrated peripherals, such as a barcode scanner, card reader, camera, and printer. Users can remotely access and control connected devices, take screenshots, rollout OTA upgrades, and use remote desktop capabilities for troubleshooting from any location at any time. Moreover, DeviceOn/iService supports batch operations to facilitate the management of multiple devices simultaneously for easy and convenient device configuration and deployment.



Total Management

- 
Devices & Hardware
 - Windows, Linux, Android
 - Hardware, storage, battery
- 
Software & Peripherals
 - Software monitoring & access
 - Screens, USB devices, printers
- 
Open for Expansion
 - Peripheral integration
 - Open APIs for integration

Remote Access

- 
Real-Time Monitoring
 - Connection/hardware status
 - Software/peripheral status
 - Failure notifications
- 
Remote Controls
 - Power controls
 - Audio, backlight controls
 - Software controls
- 
Troubleshooting
 - Screenshots
 - Remote desktop support

Operational Efficiency

- 
OTA updates
 - System/software updates
 - File repository management
 - App store
- 
Batch Controls
 - 1-to-many batch reboot, etc.
 - Time-saving tasks
- 
Setup Booster
 - Software/peripheral watchlist
 - Roles, rule templates

Note: Some functions may vary according to the product

System Architecture

